

# IH 45 NORTH - UNIVERSE OF ALTERNATIVES

**PRELIMINARY: SUBJECT TO CHANGE**

## SEGMENT 3

LIMITS: IH 10 TO IH 45/US 59 INTERCHANGE  
 LENGTH: 2.8 MILES  
 ESTIMATED COST (CONSTRUCTION & DESIGN):

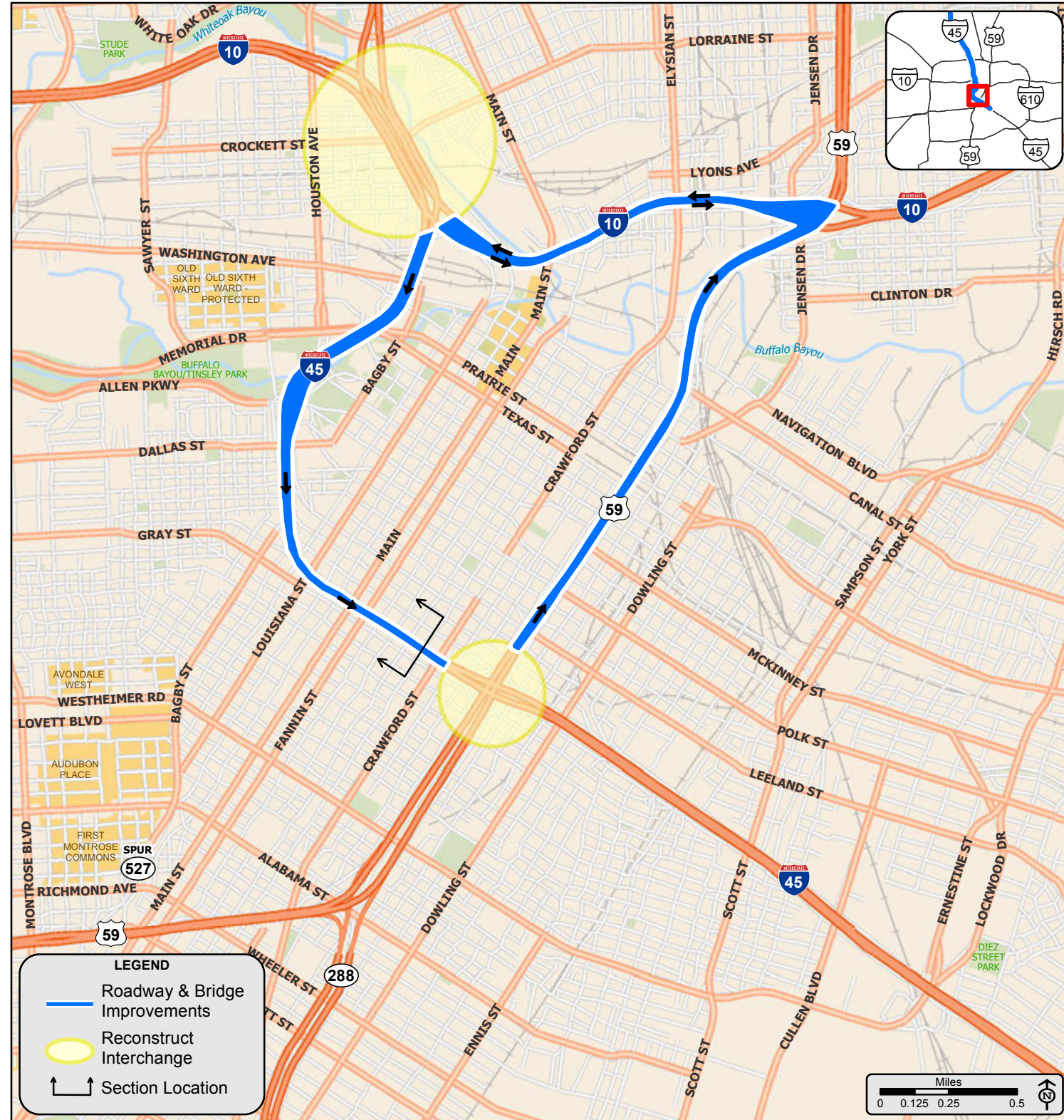

### EXISTING TYPICAL SECTION - IH 45

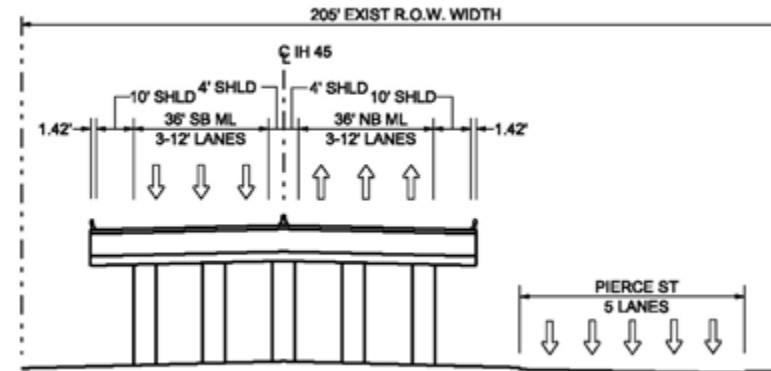

**SELECTED AS PRELIMINARY ALTERNATIVE**

### PROPOSED TYPICAL SECTION - IH 45 (ALTERNATIVE 3)

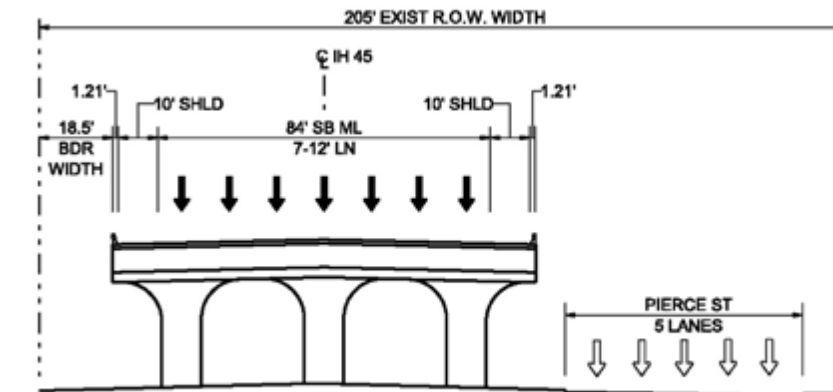

## IH 45 NORTH HOUSTON HIGHWAY IMPROVEMENT PROJECT

HARRIS COUNTY





# IH 45 NORTH - UNIVERSE OF ALTERNATIVES

**PRELIMINARY: SUBJECT TO CHANGE**

## SEGMENT 3

LIMITS: IH 10 TO IH 45/US 59 INTERCHANGE  
 LENGTH: 2.8 MILES  
 ESTIMATED COST (CONSTRUCTION & DESIGN):

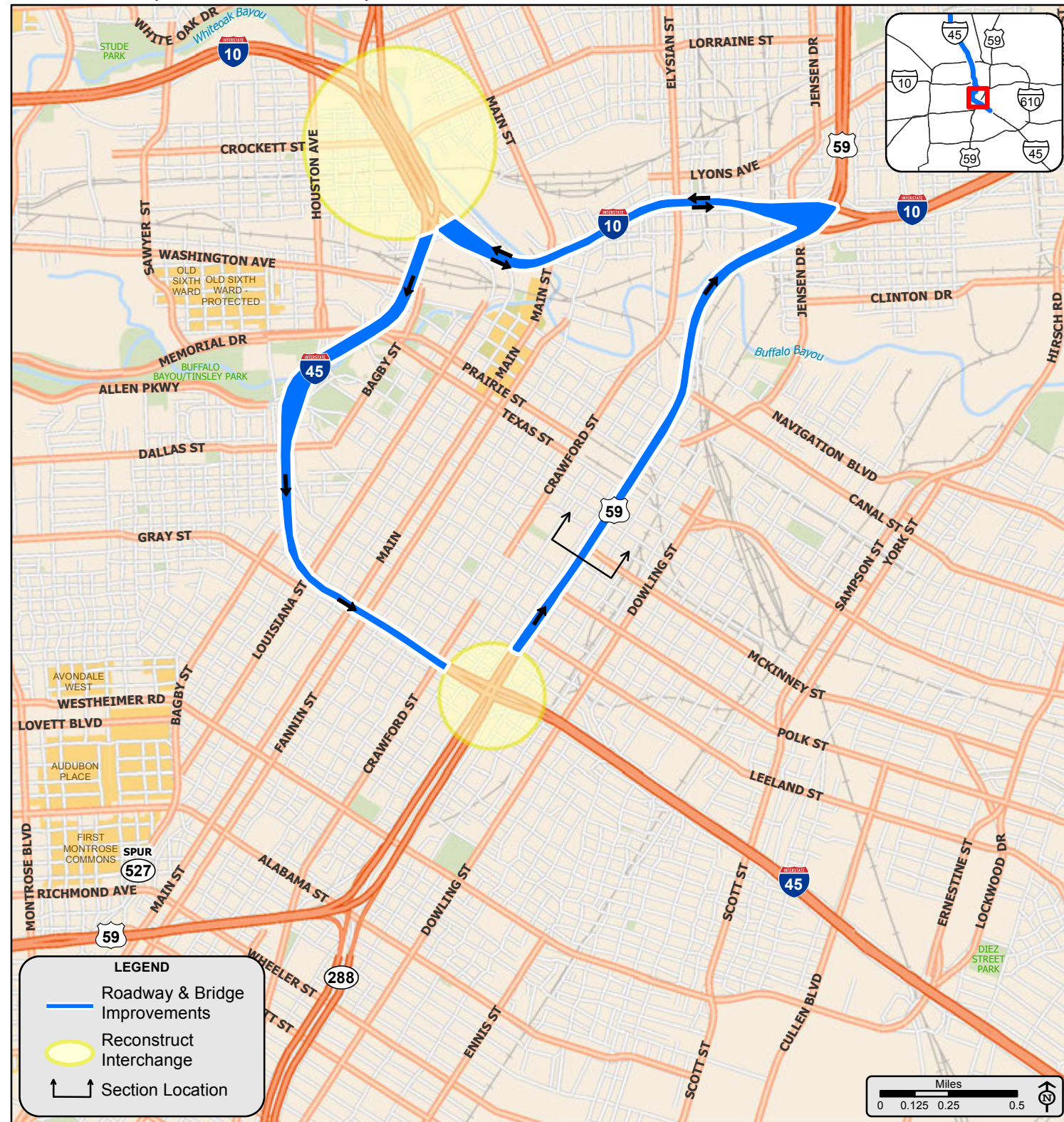

## EXISTING TYPICAL SECTION - US 59

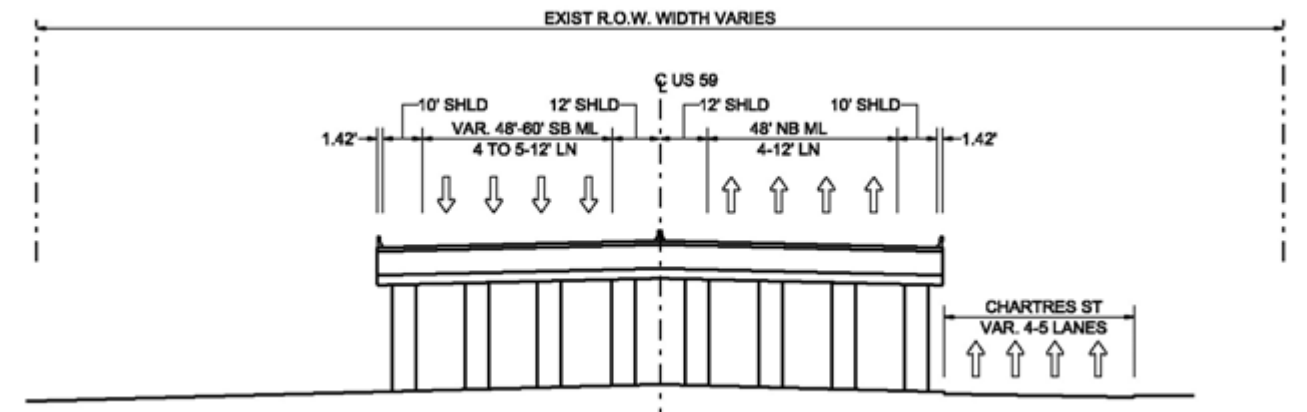

**SELECTED AS PRELIMINARY ALTERNATIVE**

## PROPOSED TYPICAL SECTION - US 59 (ALTERNATIVE 3)

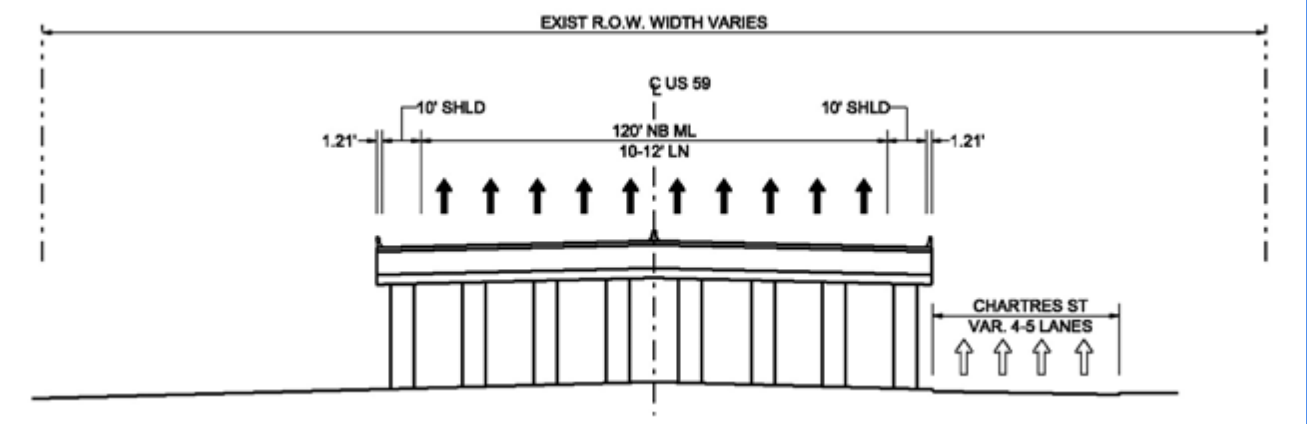

## IH 45 NORTH HOUSTON HIGHWAY IMPROVEMENT PROJECT

HARRIS COUNTY





# IH 45 NORTH - UNIVERSE OF ALTERNATIVES

**PRELIMINARY: SUBJECT TO CHANGE**

## SEGMENT 3

LIMITS: IH 10 TO IH 45/US 59 INTERCHANGE  
 LENGTH: 2.8 MILES  
 ESTIMATED COST (CONSTRUCTION & DESIGN):

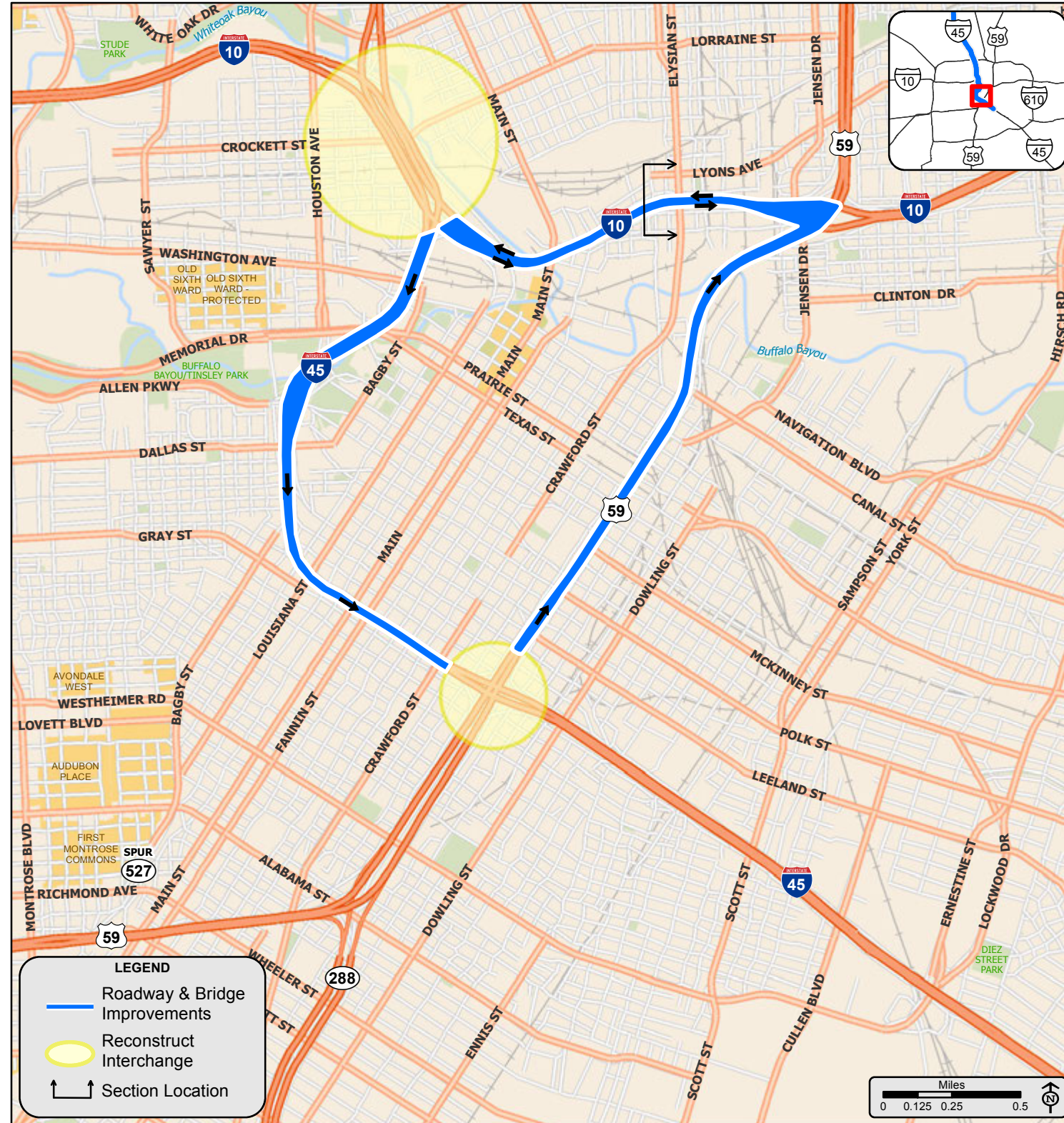

### EXISTING TYPICAL SECTION - IH 10

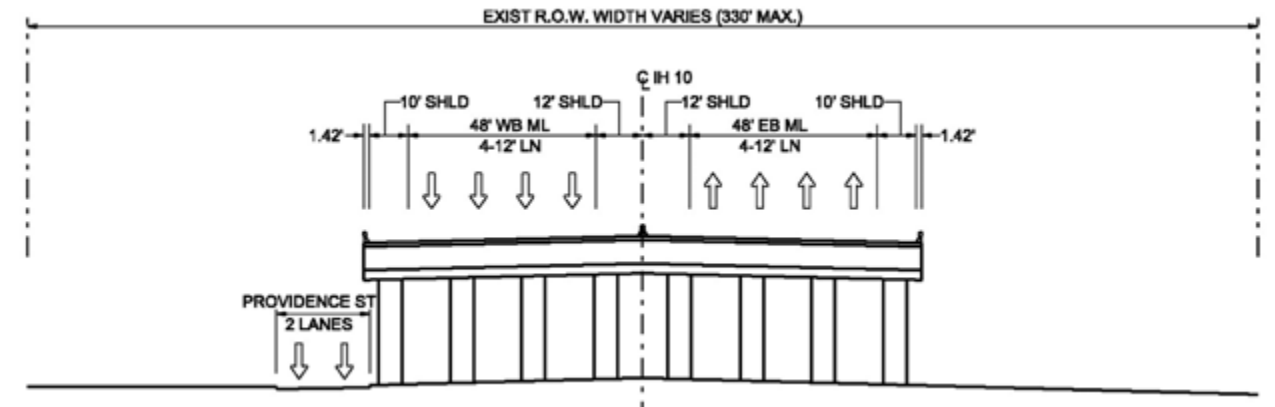

**SELECTED AS PRELIMINARY ALTERNATIVE**

### PROPOSED TYPICAL SECTION - IH 10 (ALTERNATIVE 3)

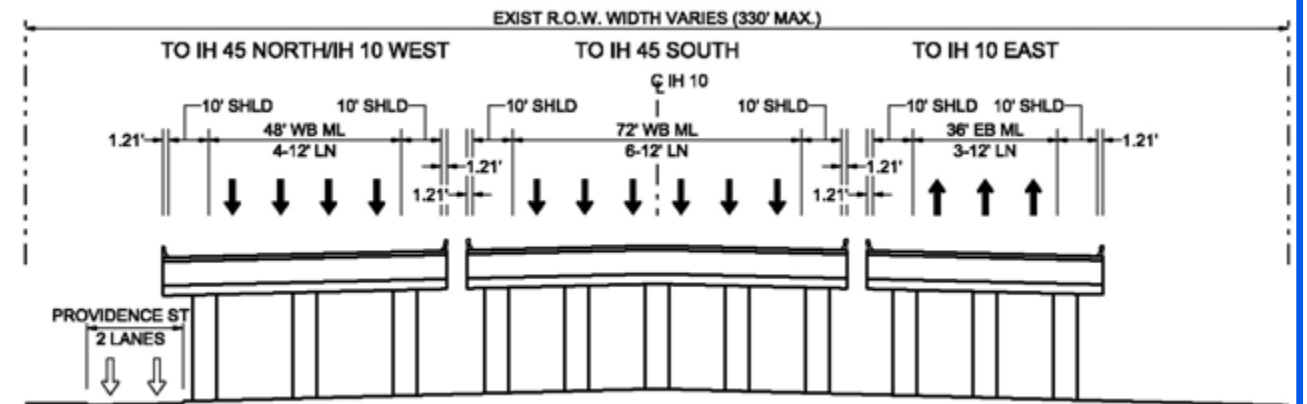

## IH 45 NORTH HOUSTON HIGHWAY IMPROVEMENT PROJECT

HARRIS COUNTY





# IH 45 NORTH - UNIVERSE OF ALTERNATIVES

**PRELIMINARY: SUBJECT TO CHANGE**

## SEGMENT 3

LIMITS: IH 10 TO IH 45/US 59 INTERCHANGE  
 LENGTH: 2.8 MILES  
 ESTIMATED COST (CONSTRUCTION & DESIGN):



**SELECTED AS PRELIMINARY ALTERNATIVE**

### PROPOSED TYPICAL SECTION - LA BRANCH (ALTERNATIVE 4)

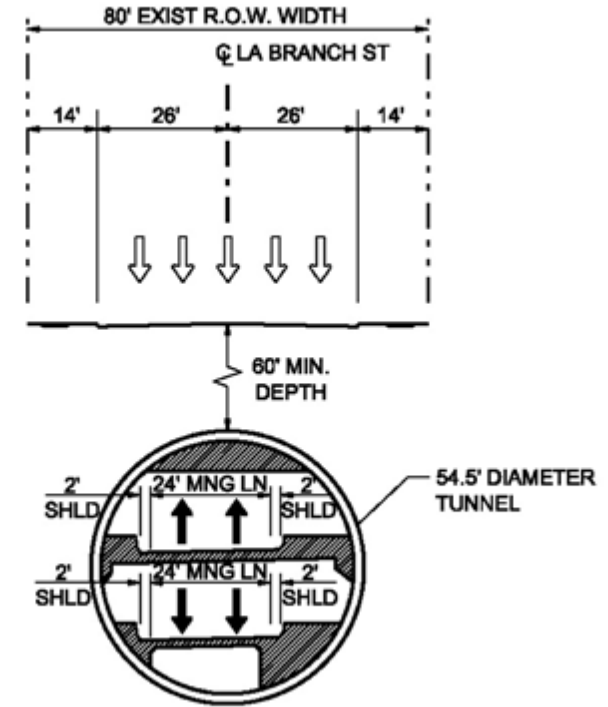

### PROPOSED TYPICAL SECTION - CRAWFORD (ALTERNATIVE 4)

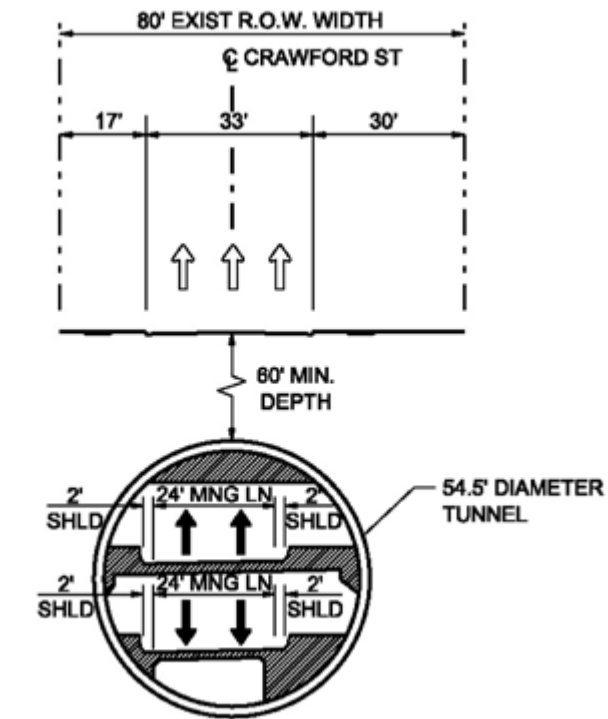

## IH 45 NORTH HOUSTON HIGHWAY IMPROVEMENT PROJECT

HARRIS COUNTY





# IH 45 NORTH - UNIVERSE OF ALTERNATIVES

**PRELIMINARY: SUBJECT TO CHANGE**

## SEGMENT 3

LIMITS: IH 10 TO IH 45/US 59 INTERCHANGE  
 LENGTH: 2.8 MILES  
 ESTIMATED COST (CONSTRUCTION & DESIGN):

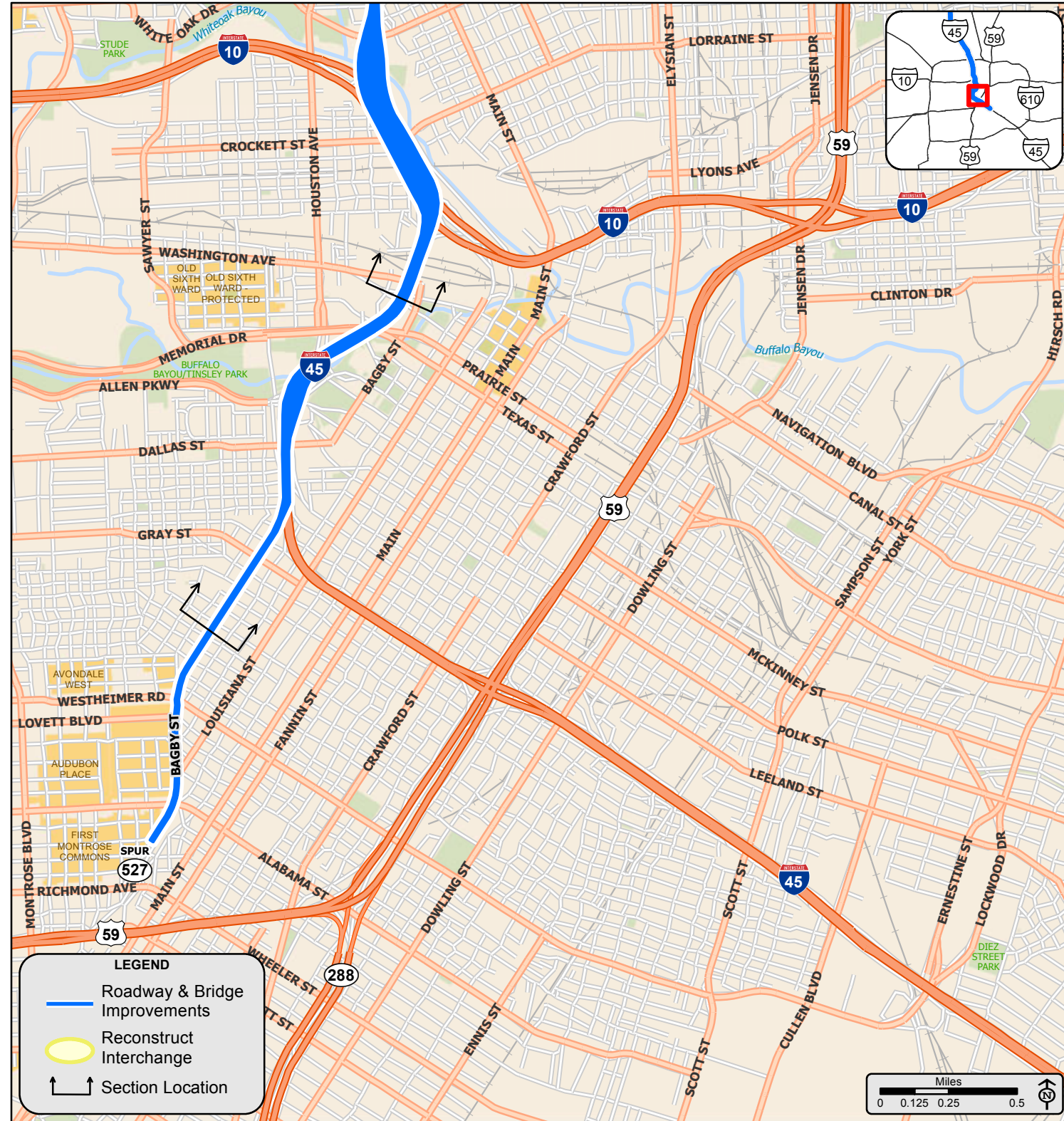

**SELECTED AS PRELIMINARY ALTERNATIVE**

### PROPOSED TYPICAL SECTION - IH 45 (ALTERNATIVE 5)

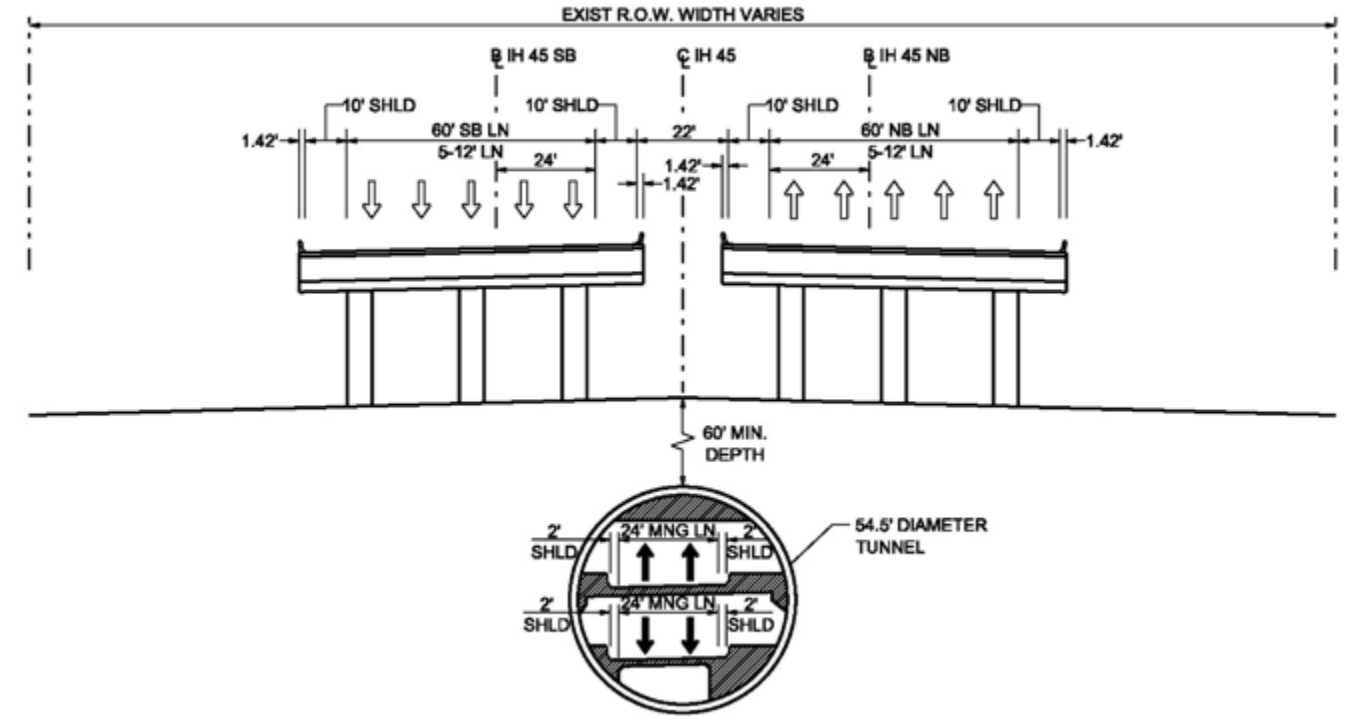

### PROPOSED TYPICAL SECTION - BAGBY (ALTERNATIVE 5)

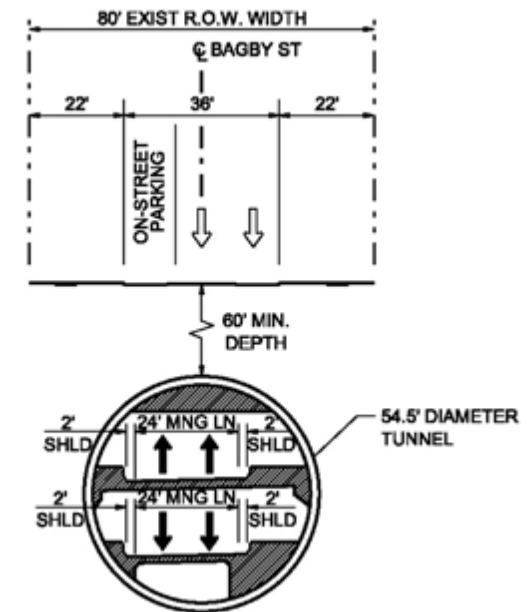

## IH 45 NORTH HOUSTON HIGHWAY IMPROVEMENT PROJECT

HARRIS COUNTY





# IH 45 NORTH - UNIVERSE OF ALTERNATIVES

**PRELIMINARY: SUBJECT TO CHANGE**

## SEGMENT 3

LIMITS: IH 10 TO IH 45/US 59 INTERCHANGE  
 LENGTH: 2.8 MILES  
 ESTIMATED COST (CONSTRUCTION & DESIGN):

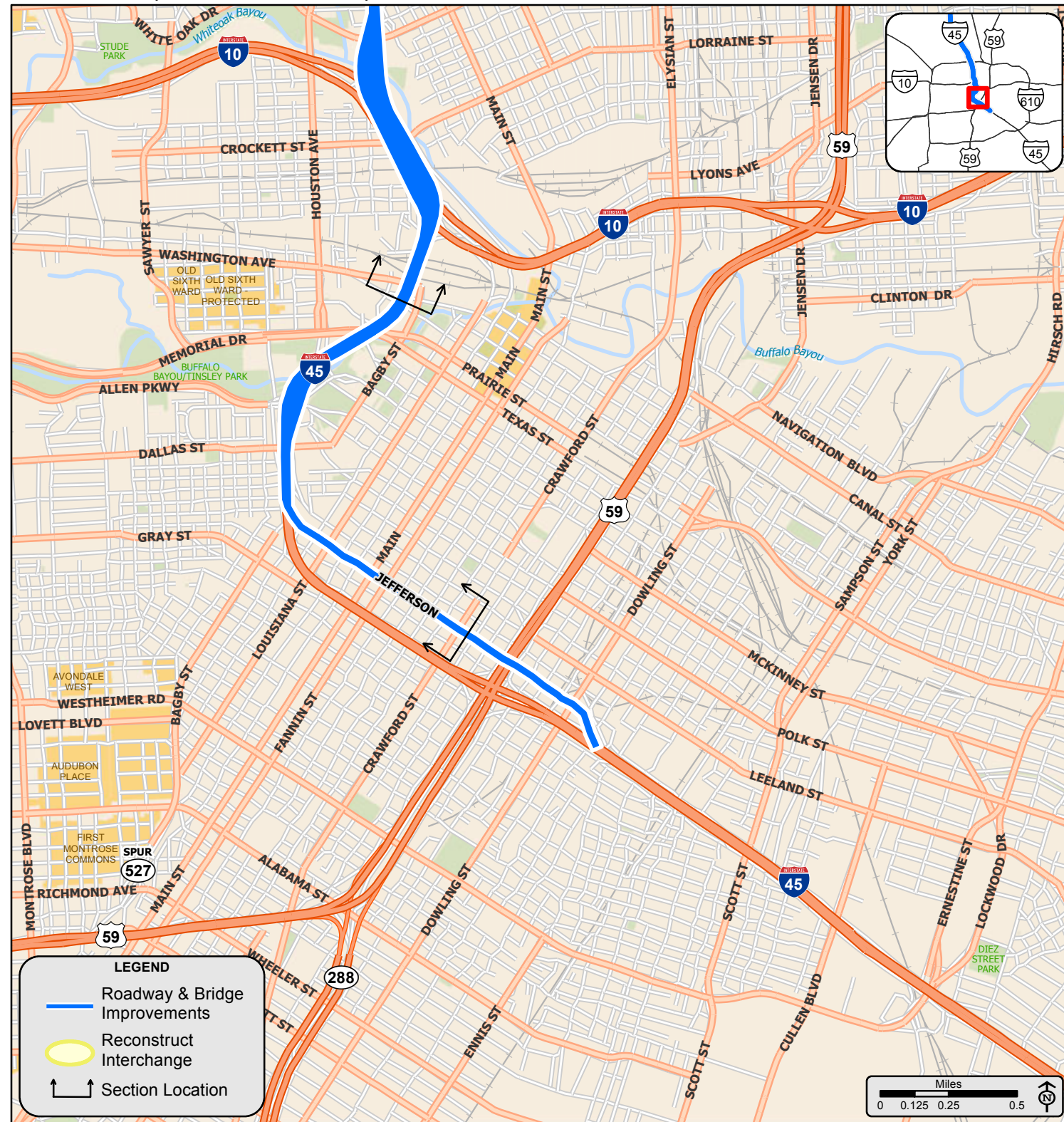

**SELECTED AS PRELIMINARY ALTERNATIVE**

### PROPOSED TYPICAL SECTION - IH 45 (ALTERNATIVE 6)

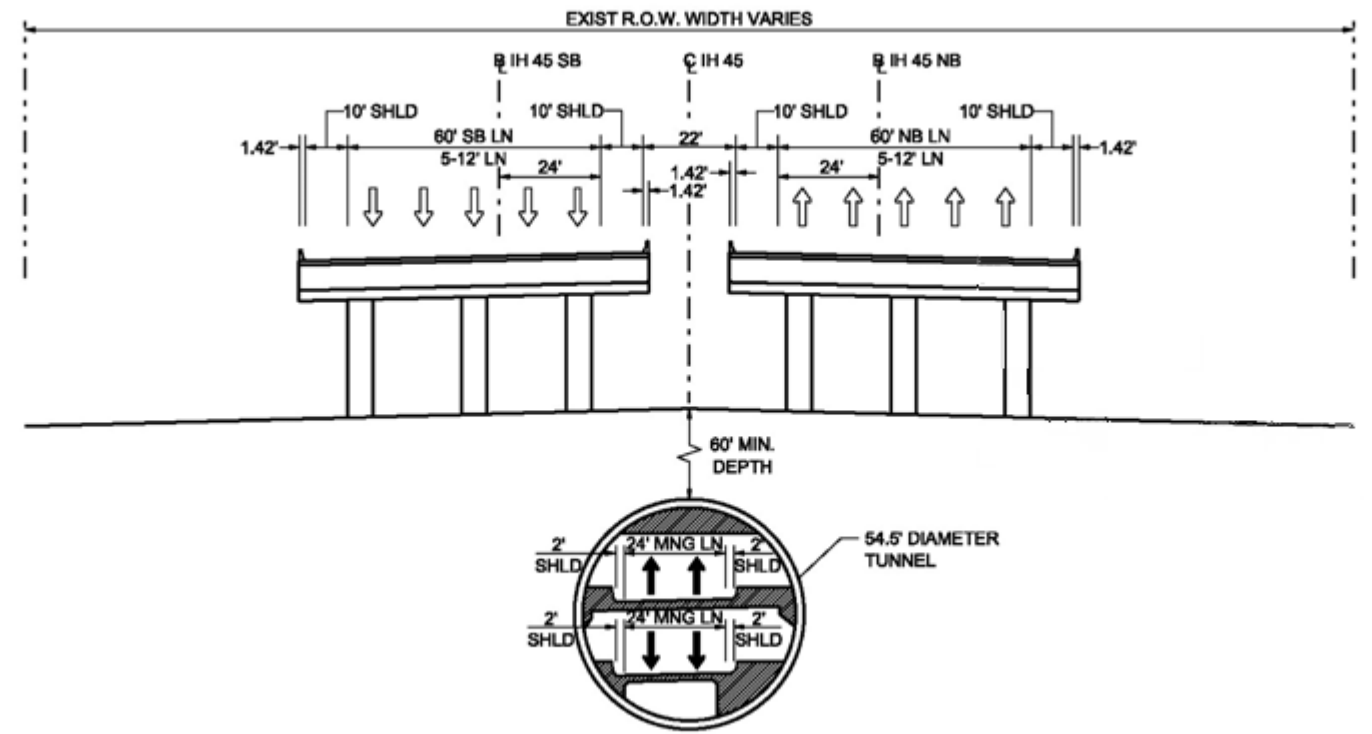

### PROPOSED TYPICAL SECTION - JEFFERSON (ALTERNATIVE 6)

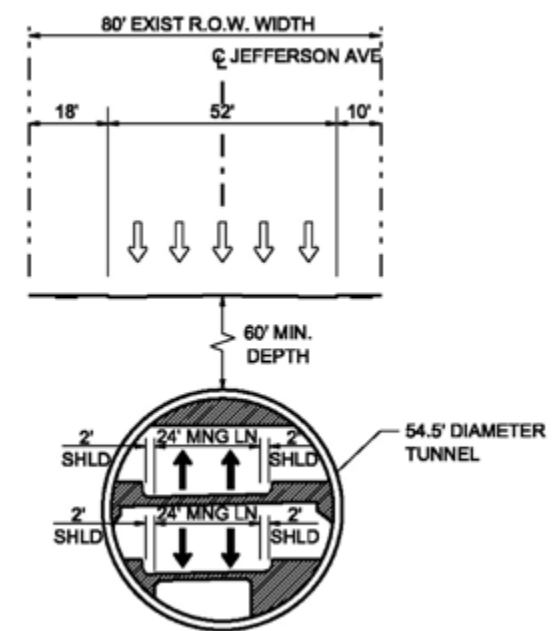

## IH 45 NORTH HOUSTON HIGHWAY IMPROVEMENT PROJECT

HARRIS COUNTY





# IH 45 NORTH - UNIVERSE OF ALTERNATIVES

**PRELIMINARY: SUBJECT TO CHANGE**

**SEGMENT 3**  
 LIMITS: IH 10 TO IH 45/US 59 INTERCHANGE  
 LENGTH: 2.8 MILES  
 ESTIMATED COST (CONSTRUCTION & DESIGN):

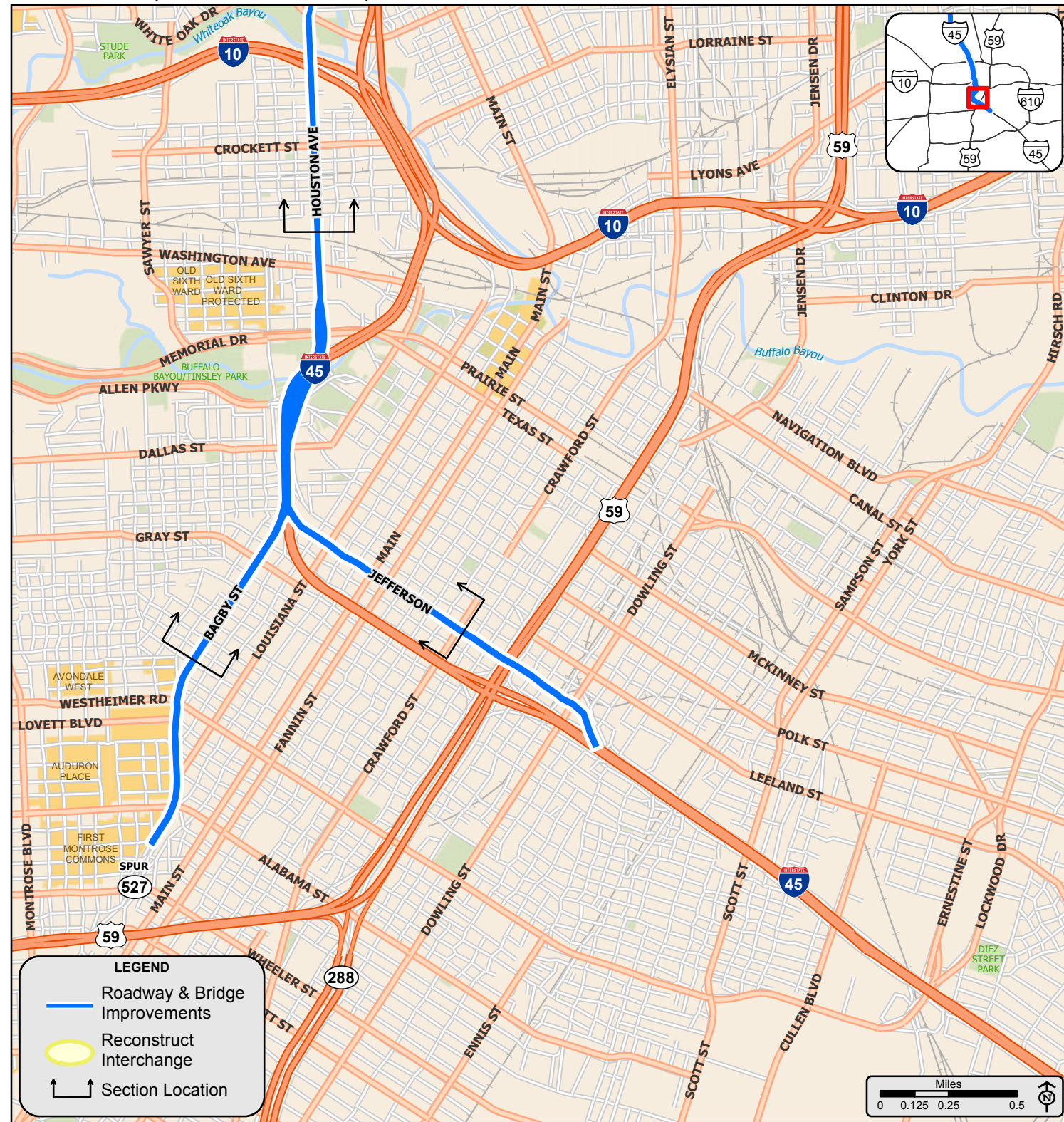

**SELECTED AS PRELIMINARY ALTERNATIVE**

**PROPOSED TYPICAL SECTION - HOUSTON (ALTERNATIVE 7)**

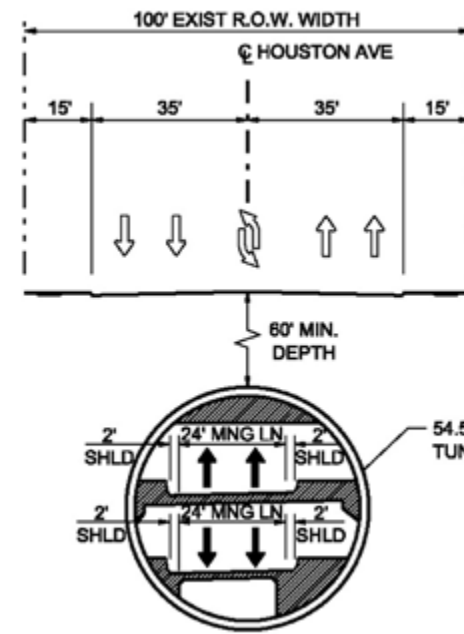

**PROPOSED TYPICAL SECTION - JEFFERSON (ALTERNATIVE 7)**

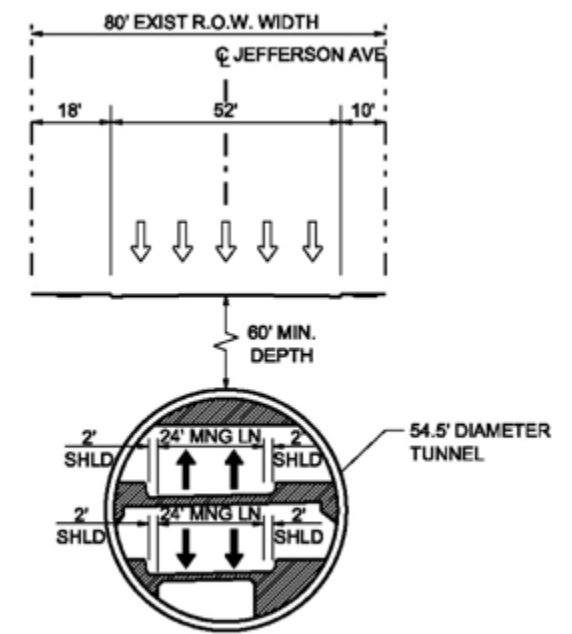

**PROPOSED TYPICAL SECTION - BAGBY (ALTERNATIVE 7)**

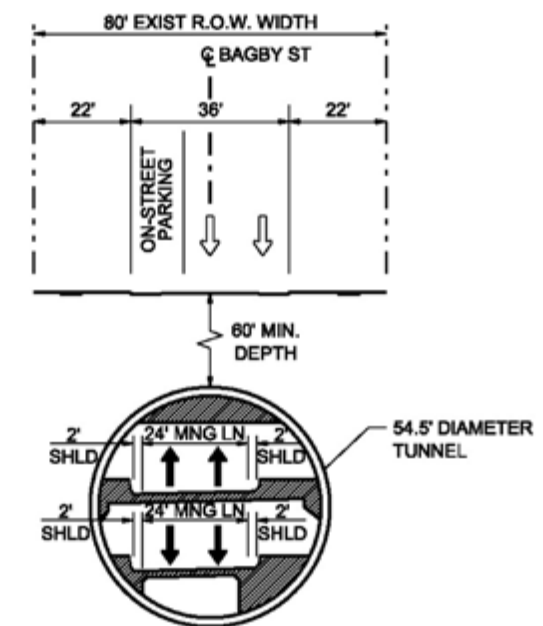

**IH 45 NORTH HOUSTON HIGHWAY IMPROVEMENT PROJECT**

**HARRIS COUNTY**





# IH 45 NORTH - UNIVERSE OF ALTERNATIVES

**PRELIMINARY: SUBJECT TO CHANGE**

## SEGMENT 3

LIMITS: IH 10 TO IH 45/US 59 INTERCHANGE  
 LENGTH: 2.8 MILES  
 ESTIMATED COST (CONSTRUCTION & DESIGN):

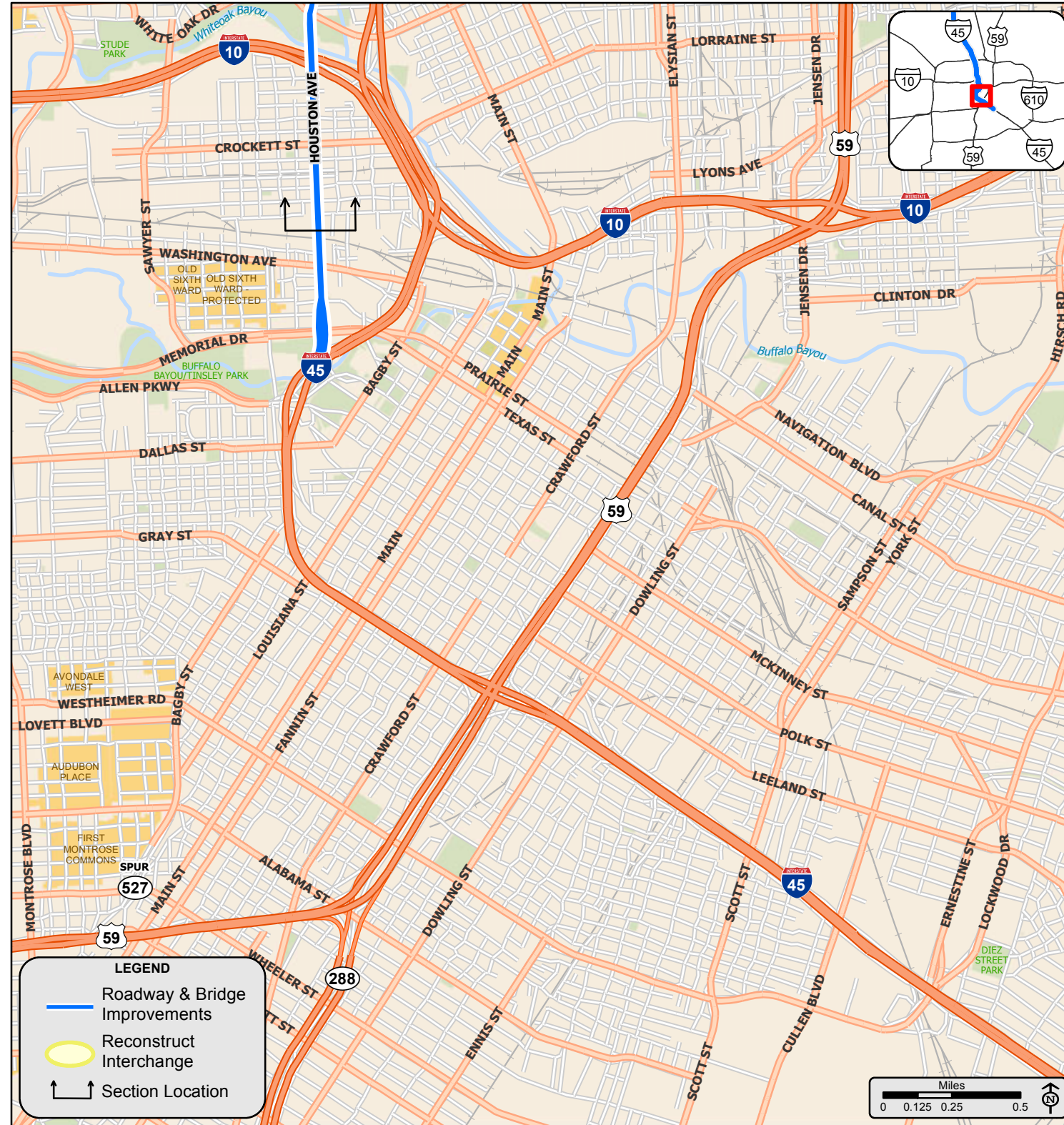

**EXISTING TYPICAL SECTION - HOUSTON**

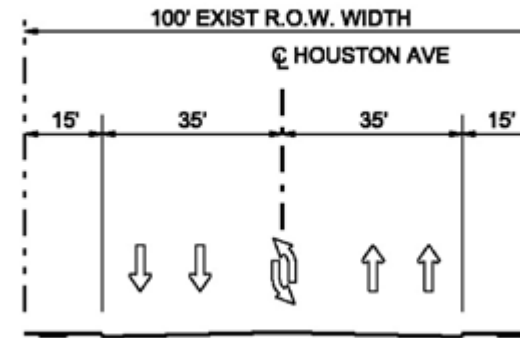

**PROPOSED TYPICAL SECTION - HOUSTON (ALTERNATIVE 8A)**

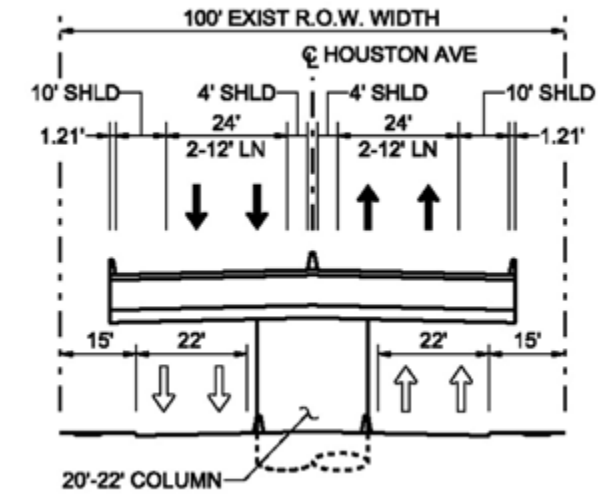

**PROPOSED TYPICAL SECTION - HOUSTON (ALTERNATIVE 8B)**

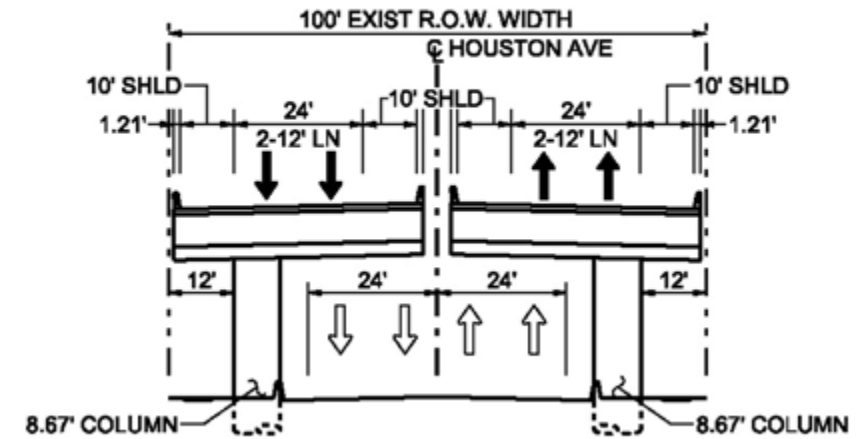

## IH 45 NORTH HOUSTON HIGHWAY IMPROVEMENT PROJECT

HARRIS COUNTY





# IH 45 NORTH - UNIVERSE OF ALTERNATIVES

**PRELIMINARY: SUBJECT TO CHANGE**

**SEGMENT 3**  
 LIMITS: IH 10 TO IH 45/US 59 INTERCHANGE  
 LENGTH: 2.8 MILES  
 ESTIMATED COST (CONSTRUCTION & DESIGN):

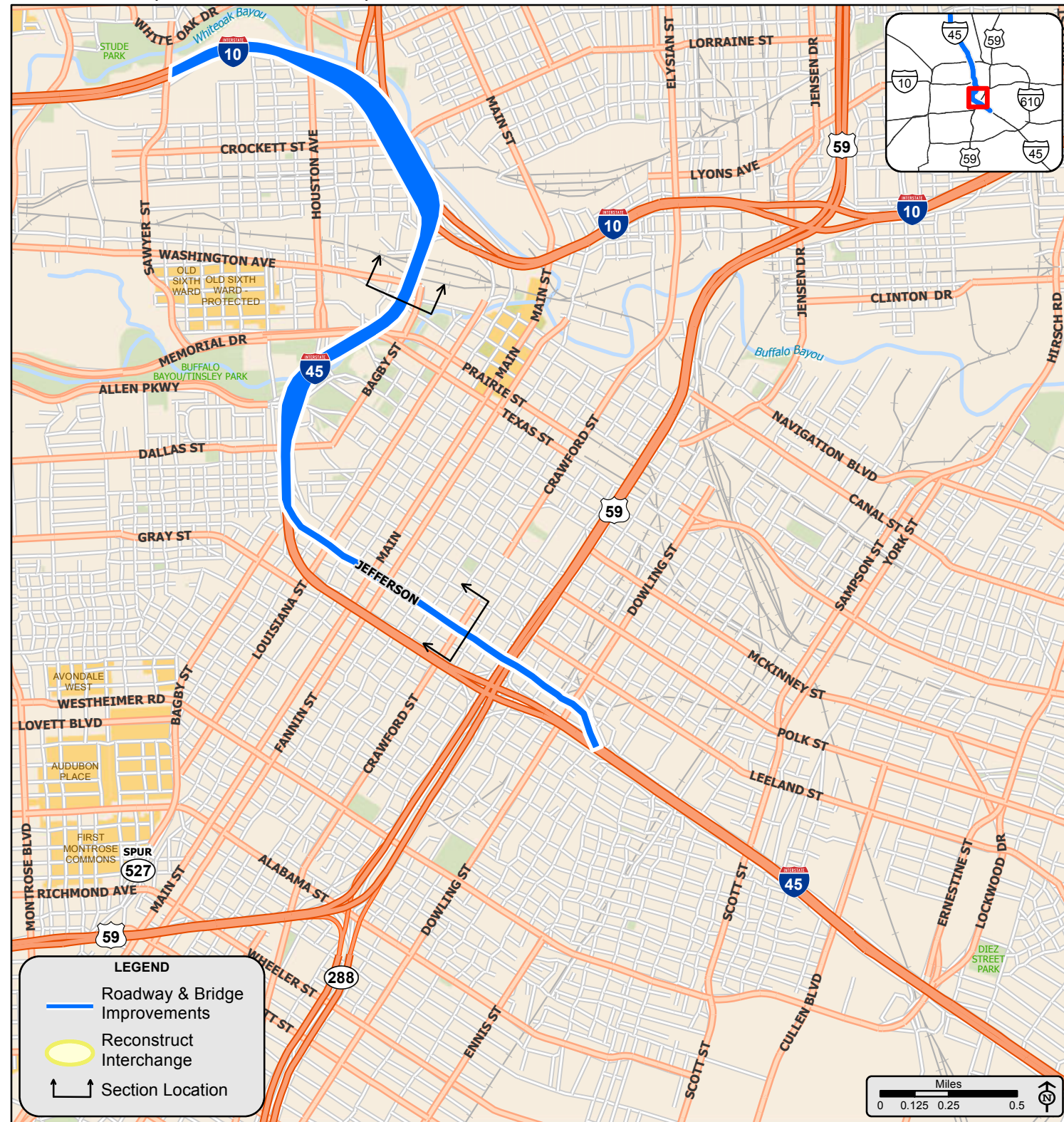

**PROPOSED TYPICAL SECTION - IH 45 (ALTERNATIVE 9)**

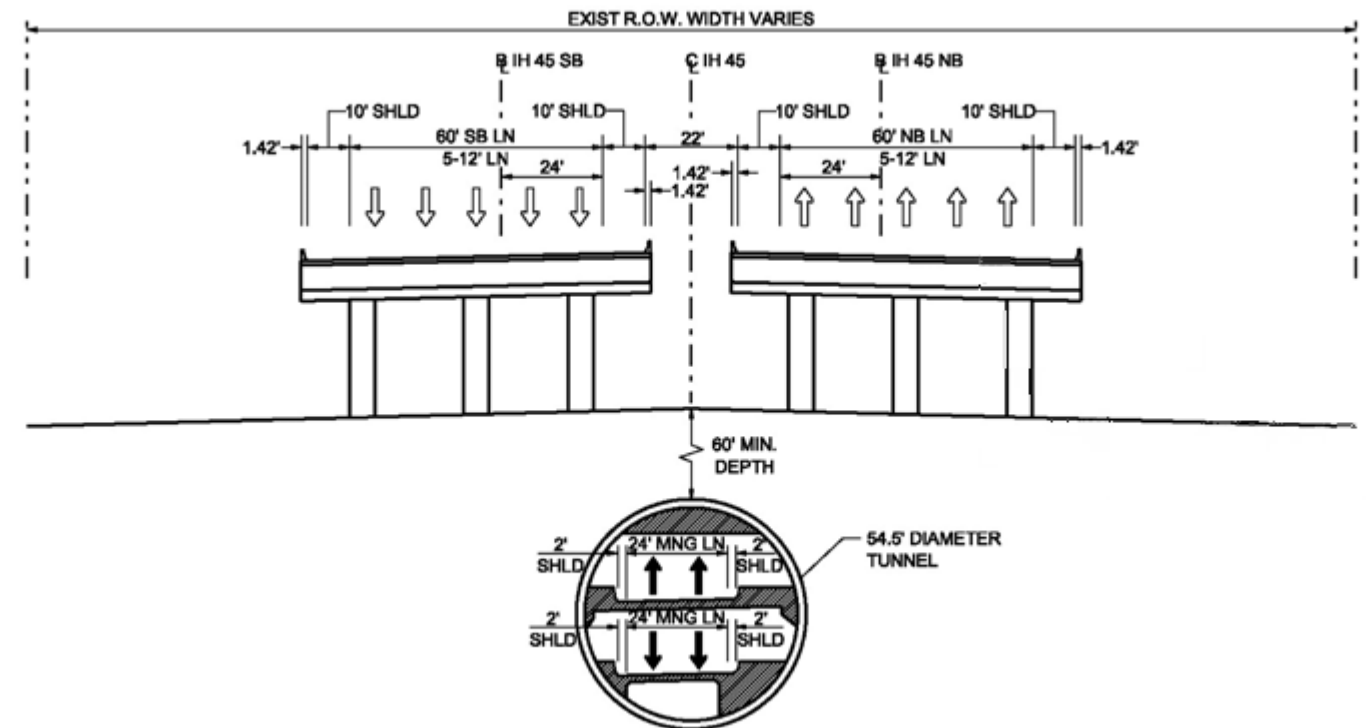

**PROPOSED TYPICAL SECTION - JEFFERSON (ALTERNATIVE 9)**

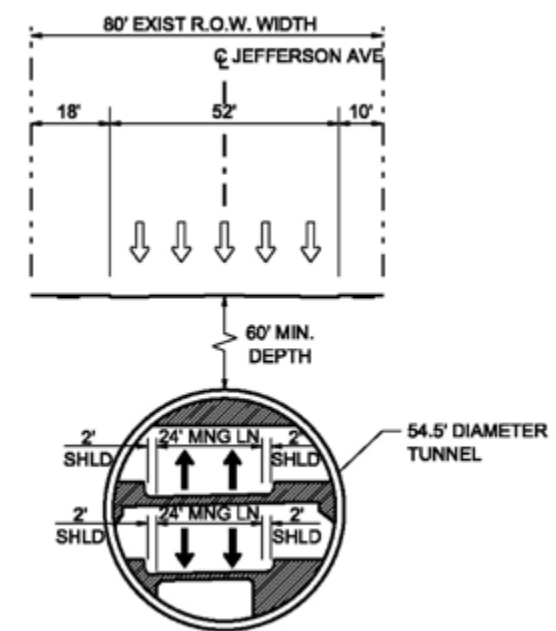

**IH 45 NORTH HOUSTON HIGHWAY IMPROVEMENT PROJECT**

**HARRIS COUNTY**





# IH 45 NORTH - UNIVERSE OF ALTERNATIVES

**PRELIMINARY: SUBJECT TO CHANGE**

## SEGMENT 3

LIMITS: IH 10 TO IH 45/US 59 INTERCHANGE  
 LENGTH: 2.8 MILES  
 ESTIMATED COST (CONSTRUCTION & DESIGN):

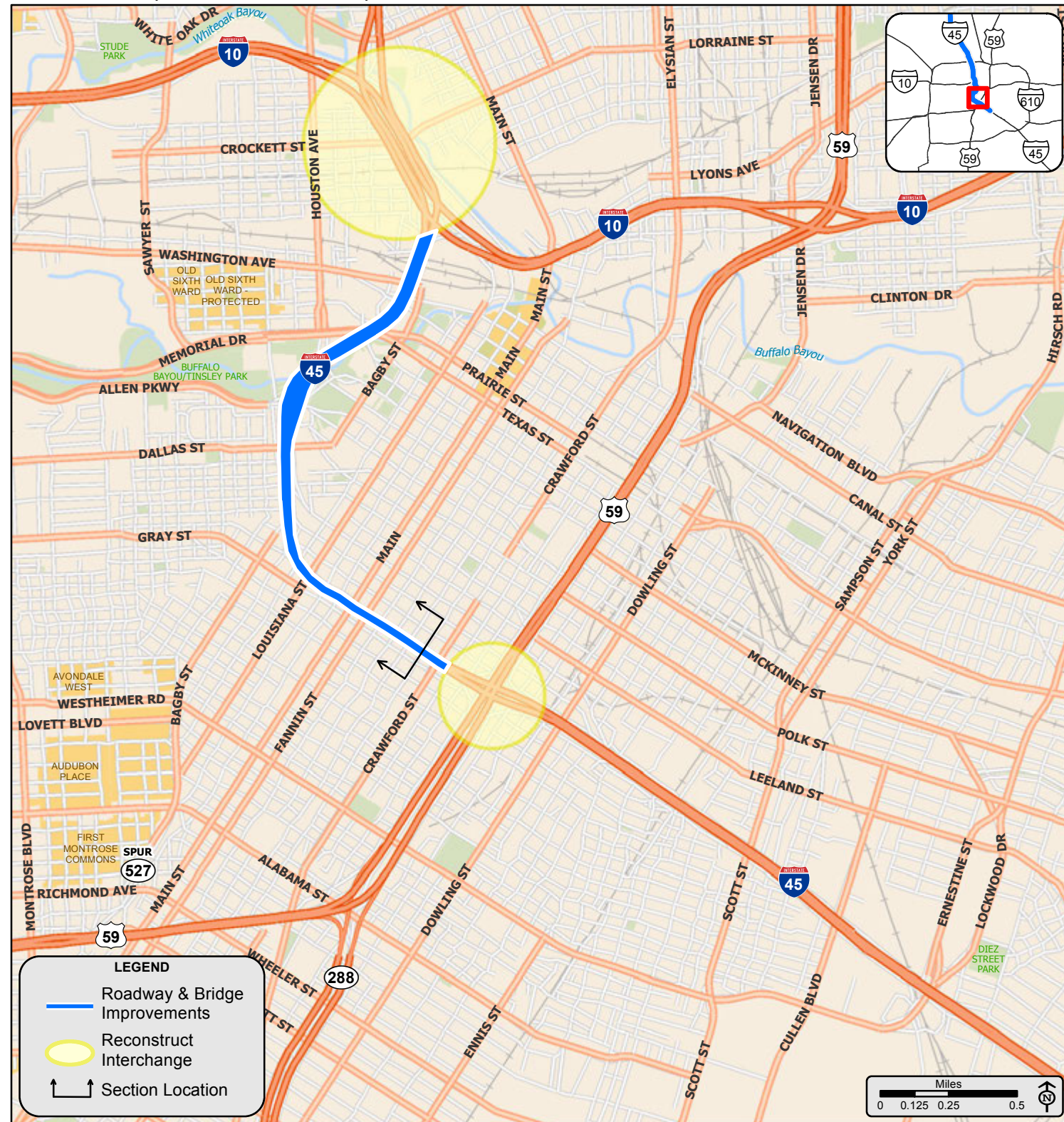

## EXISTING TYPICAL SECTION - IH 45

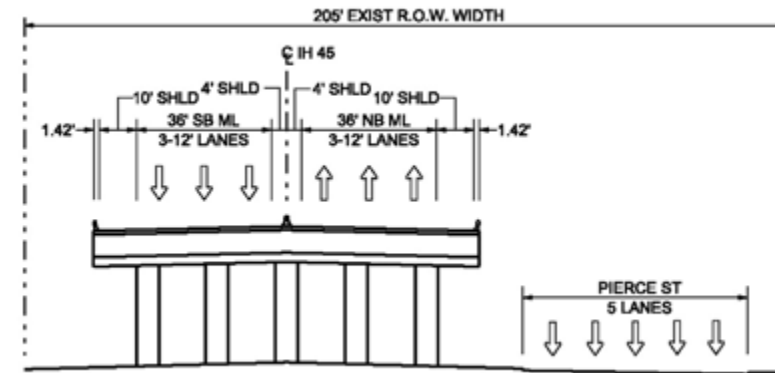

**SELECTED AS PRELIMINARY ALTERNATIVE**

## PROPOSED TYPICAL SECTION - IH 45 (ALTERNATIVE 10)

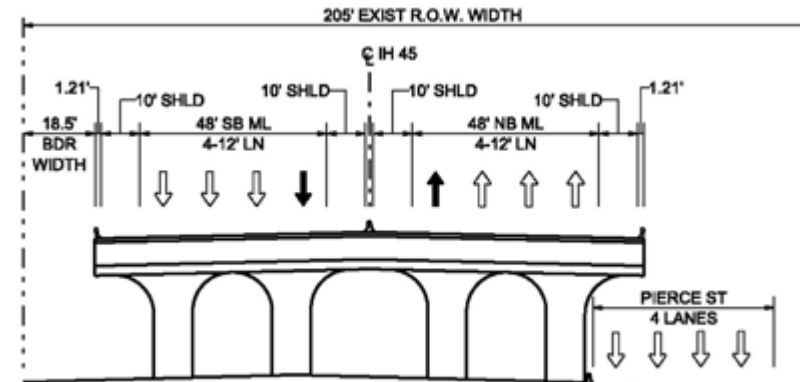

## IH 45 NORTH HOUSTON HIGHWAY IMPROVEMENT PROJECT

HARRIS COUNTY

